

NECESSARY TOOLS

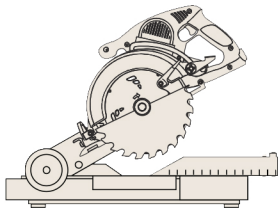

Chop Saw

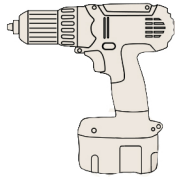

Screwdriver

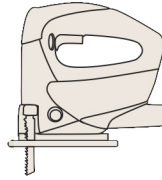

Electrofret

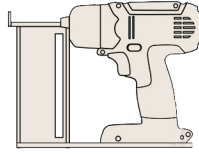

Finishing Nailer
ONLY

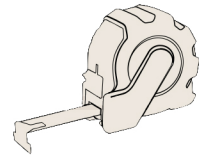

Tape
Measurement



Water
Sprayer



Work Gloves

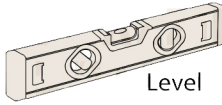

Level



Safety Glasses



Liquid Nails



Doors and Windows
Construction Foam

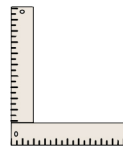

Square

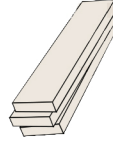

Shims

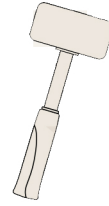

Rubber
Hammer



Knife

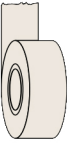

Masking
Tape

DOOR PARTS

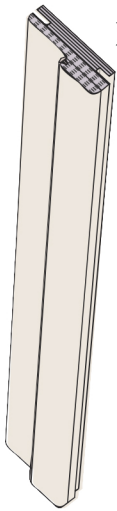

x2,5

JAMB

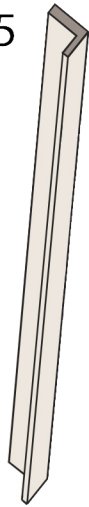

x5

CASING

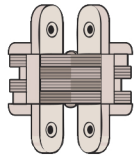

x2

HINGES

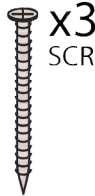

x3
SCREW 2 1/2"



x7
SCREW 1 5/8"



x6
SCREW 1 1/4"

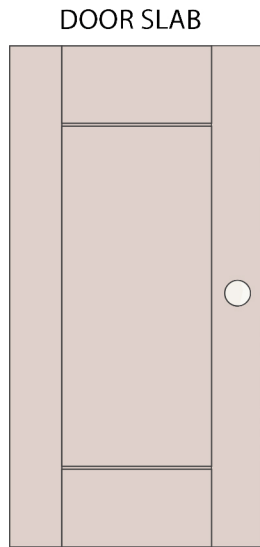

DOOR SLAB

x1

EXTENSION

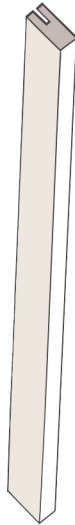

x2,5

WARNING!

DO NOT USE STANDARD
NAILS AND HAMMER

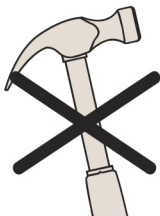
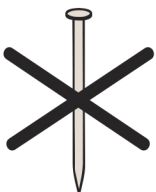

DO NOT STEP ON THE DOOR

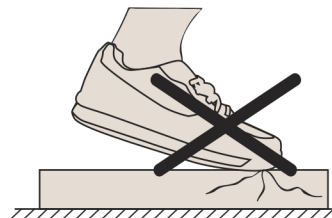

DO NOT LAY
DOWN ON EDGES

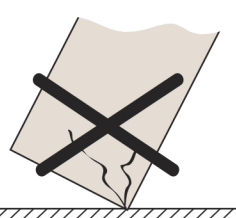

DO NOT LEAN
ON THE WALL

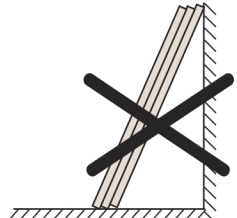

1

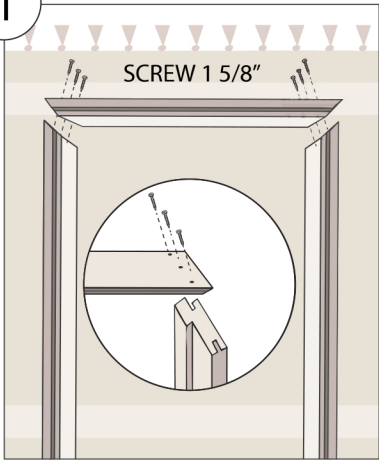

2

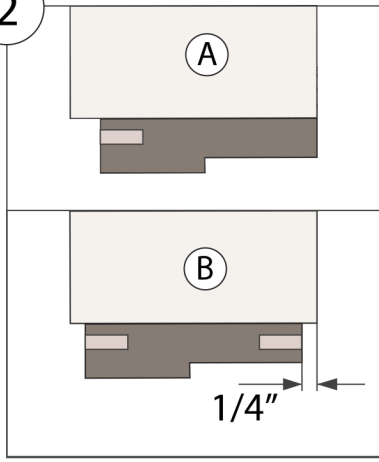

3

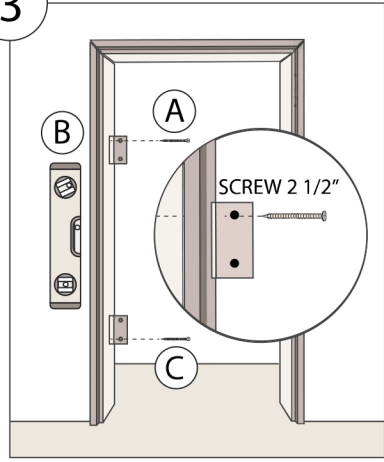

4

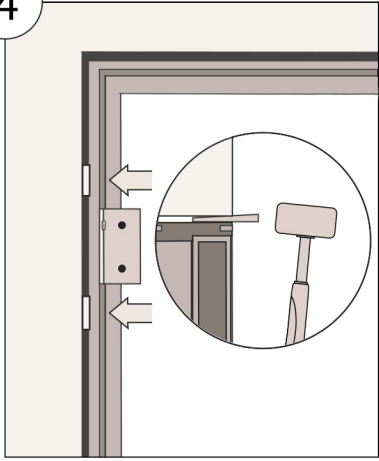

5

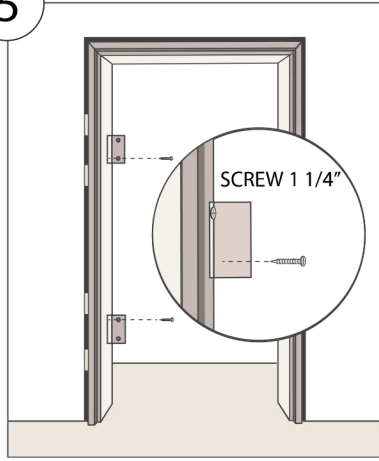

6

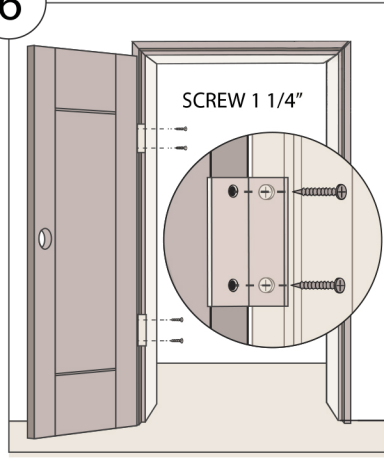

7

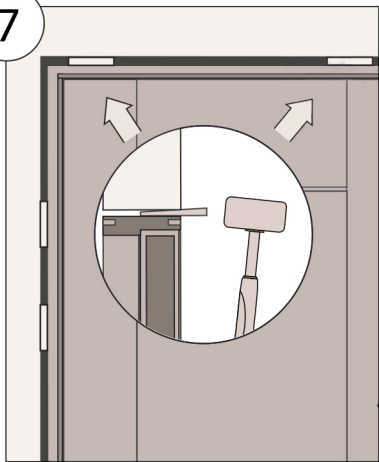

8

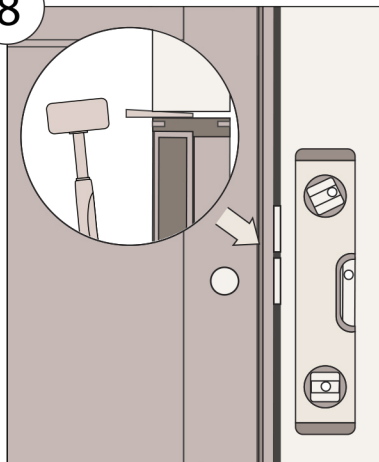

9

